

## N-channel Enhanced mode TO-220F/TO-262/TO-220/TO-263 MOSFET

### Features

- High ruggedness
- Low  $R_{DS(ON)}$  (Typ 0.7 $\Omega$ )@ $V_{GS}=10V$
- Low Gate Charge (Typ 45nC)
- Improved dv/dt Capability
- 100% Avalanche Tested
- Application:Charger,LED,PC Power

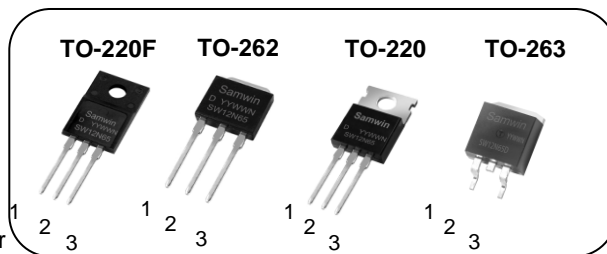

1. Gate 2. Drain 3. Source

$BV_{DSS}$  : 650V

$I_D$  : 12A

$R_{DS(ON)}$  : 0.7 $\Omega$

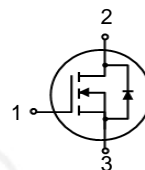

### General Description

This power MOSFET is produced with advanced technology of SAMWIN.

This technology enable the power MOSFET to have better characteristics, including fast switching time, low on resistance, low gate charge and especially excellent avalanche characteristics.



### Order Codes

Item	Sales Type	Marking	Package	Packaging
1	SW F 12N65D	SW12N65D	TO-220F	TUBE
2	SW U 12N65D	SW12N65D	TO-262	TUBE
3	SW P 12N65D	SW12N65D	TO-220	TUBE
4	SW B 12N65D	SW12N65D	TO-263	REEL

### Absolute maximum ratings

Symbol	Parameter	Value				Unit
		TO-220F	TO-262	TO-220	TO-263	
$V_{DSS}$	Drain to source voltage	650				V
$I_D$	Continuous drain current (@ $T_C=25^\circ C$ )	12*				A
	Continuous drain current (@ $T_C=100^\circ C$ )	7.6*				A
$I_{DM}$	Drain current pulsed (note 1)	48				A
$V_{GS}$	Gate to source voltage	$\pm 30$				V
$E_{AS}$	Single pulsed avalanche energy (note 2)	605				mJ
$E_{AR}$	Repetitive avalanche energy (note 1)	121				mJ
dv/dt	Peak diode recovery dv/dt (note 3)	5				V/ns
$P_D$	Total power dissipation (@ $T_C=25^\circ C$ )	44.6	186.6	208.3	183.8	W
	Derating factor above 25 $^\circ C$	0.36	1.49	1.67	1.47	W/ $^\circ C$
$T_{STG}, T_J$	Operating junction temperature & storage temperature	-55 ~ + 150				$^\circ C$
$T_L$	Maximum lead temperature for soldering purpose, 1/8 from case for 5 seconds.	300				$^\circ C$

\*. Drain current is limited by junction temperature.

### Thermal characteristics

Symbol	Parameter	Value				Unit
		TO-220F	TO-262	TO-220	TO-263	
$R_{thjc}$	Thermal resistance, Junction to case	2.8	0.67	0.6	0.68	$^\circ C/W$
$R_{thja}$	Thermal resistance, Junction to ambient	47.5	68	65		$^\circ C/W$

Electrical characteristic (  $T_C = 25^\circ\text{C}$  unless otherwise specified )

Symbol	Parameter	Test conditions	Min.	Typ.	Max.	Unit
<b>Off characteristics</b>						
$BV_{DSS}$	Drain to source breakdown voltage	$V_{GS}=0V, I_D=250\mu A$	650			V
$\Delta BV_{DSS} / \Delta T_J$	Breakdown voltage temperature coefficient	$I_D=250\mu A$ , referenced to $25^\circ\text{C}$		0.49		$V/^\circ\text{C}$
$I_{DSS}$	Drain to source leakage current	$V_{DS}=650V, V_{GS}=0V$			1	$\mu A$
		$V_{DS}=520V, T_C=125^\circ\text{C}$			50	$\mu A$
$I_{GSS}$	Gate to source leakage current, forward	$V_{GS}=30V, V_{DS}=0V$			100	nA
	Gate to source leakage current, reverse	$V_{GS}=-30V, V_{DS}=0V$			-100	nA
<b>On characteristics</b>						
$V_{GS(TH)}$	Gate threshold voltage	$V_{DS}=V_{GS}, I_D=250\mu A$	2.5		4.5	V
$R_{DS(ON)}$	Drain to source on state resistance	$V_{GS}=10V, I_D = 6A$		0.7	0.8	$\Omega$
$G_{fs}$	Forward transconductance	$V_{DS}=30V, I_D = 6A$		12		S
<b>Dynamic characteristics</b>						
$C_{iss}$	Input capacitance	$V_{GS}=0V, V_{DS}=25V, f=1\text{MHz}$		1456		pF
$C_{oss}$	Output capacitance			157		
$C_{rss}$	Reverse transfer capacitance			25		
$t_{d(on)}$	Turn on delay time	$V_{DS}=325V, I_D=12A, R_G=25\Omega$ (note 4,5)		24		ns
$t_r$	Rising time			51		
$t_{d(off)}$	Turn off delay time			131		
$t_f$	Fall time			56		
$Q_g$	Total gate charge	$V_{DS}=520V, V_{GS}=10V, I_D=12A$ (note 4,5)		45		nC
$Q_{gs}$	Gate-source charge			8		
$Q_{gd}$	Gate-drain charge			22		
$R_g$	Gate resistance	$V_{DS}=0V$ , Scan F mode		1.6		$\Omega$

### Source to drain diode ratings characteristics

Symbol	Parameter	Test conditions	Min.	Typ.	Max.	Unit
$I_S$	Continuous source current	Integral reverse p-n Junction diode in the MOSFET			12	A
$I_{SM}$	Pulsed source current				48	A
$V_{SD}$	Diode forward voltage drop.	$I_S=12A, V_{GS}=0V$			1.4	V
$t_{rr}$	Reverse recovery time	$I_S=12A, V_{GS}=0V,$ $di_f/dt=100A/\mu s$		430		ns
$Q_{rr}$	Reverse recovery charge			5.25		$\mu C$

#### ※. Notes

1. Repetitive rating : pulse width limited by junction temperature.
2.  $L = 8.4\text{mH}, I_{AS} = 12A, V_{DD} = 50V, R_G=25\Omega$ , Starting  $T_J = 25^\circ\text{C}$
3.  $I_{SD} \leq 12A, di/dt = 100A/\mu s, V_{DD} \leq BV_{DSS}$ , Starting  $T_J = 25^\circ\text{C}$
4. Pulse Test : Pulse Width  $\leq 300\mu s$ , duty cycle  $\leq 2\%$ .
5. Essentially independent of operating temperature.

**Fig. 1. On-state characteristics**

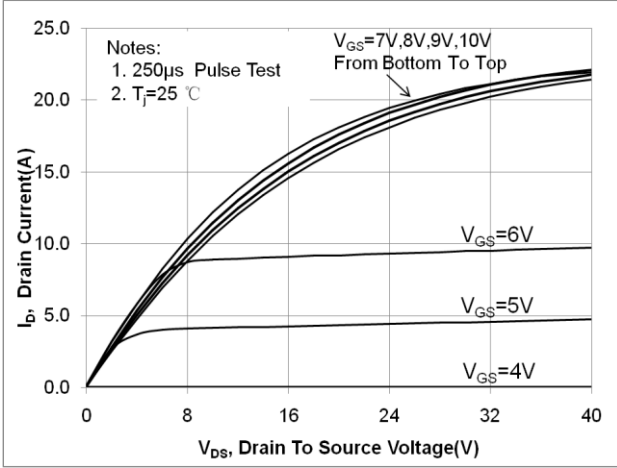

**Fig. 2. Transfer characteristics**

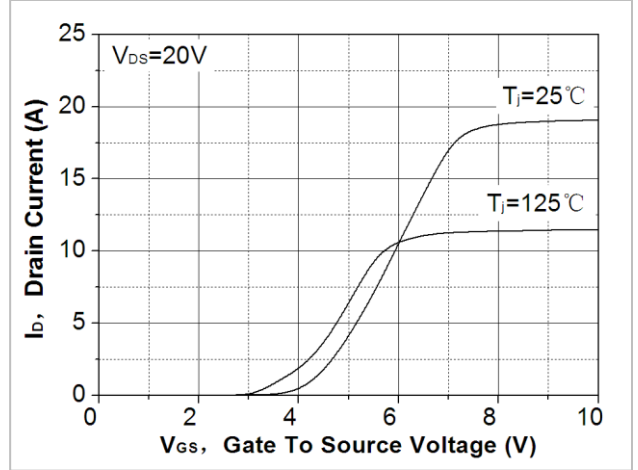

**Fig. 3. On-resistance variation vs. drain current and gate voltage**

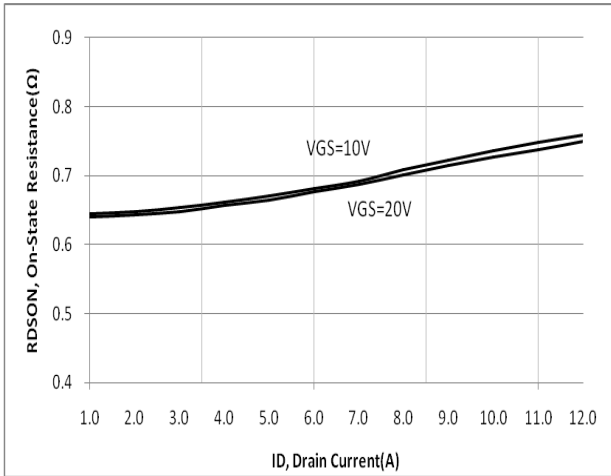

**Fig. 4. On state current vs. diode forward voltage**

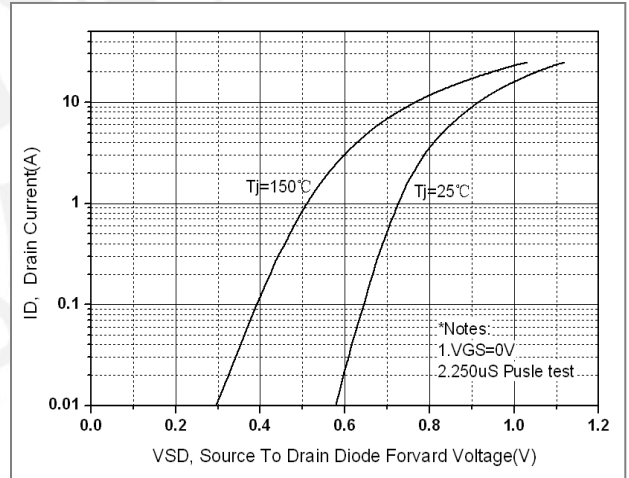

**Fig 5. Breakdown Voltage Variation vs. Junction Temperature**

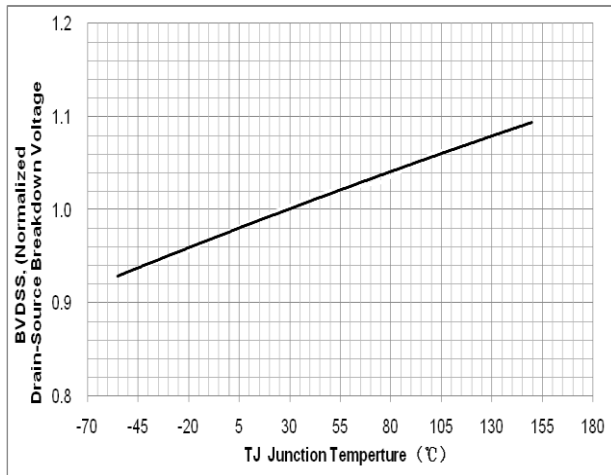

**Fig. 6. On resistance variation vs. junction temperature**

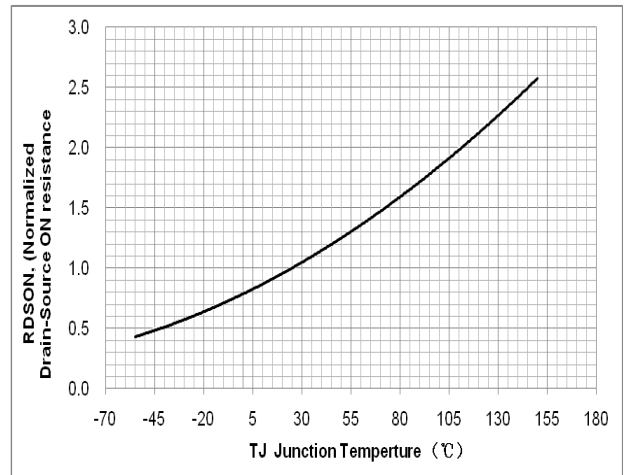

Fig. 7. Gate charge characteristics

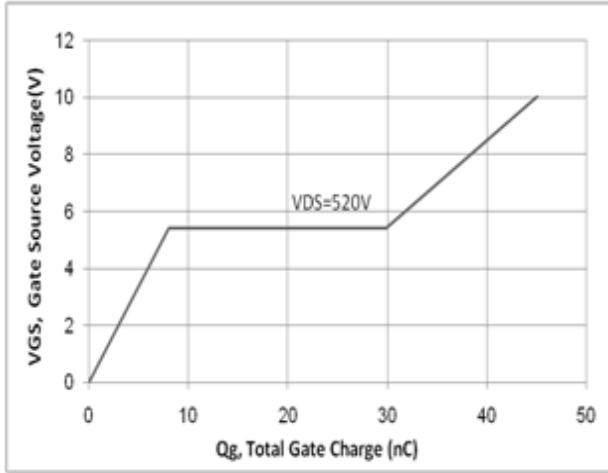

Fig. 8. Capacitance Characteristics

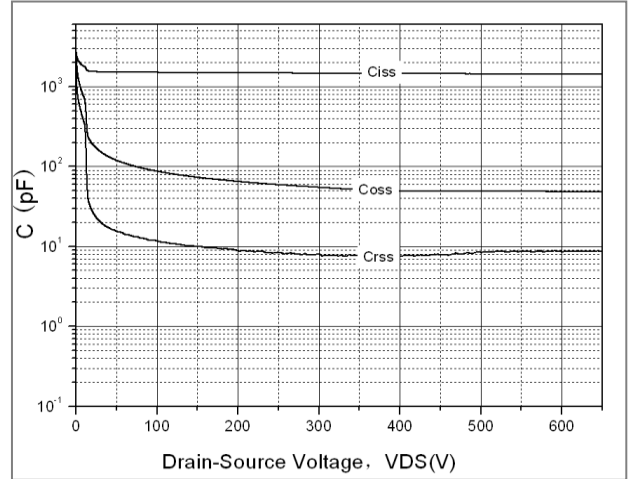

Fig. 9. Maximum safe operating area (TO-220F)

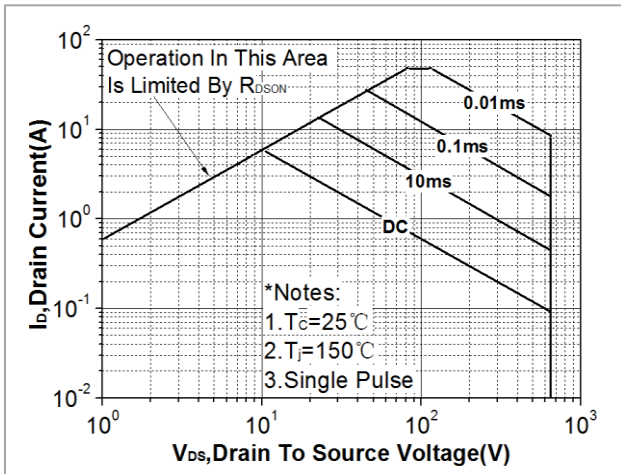

Fig. 10. Maximum safe operating area (TO-262)

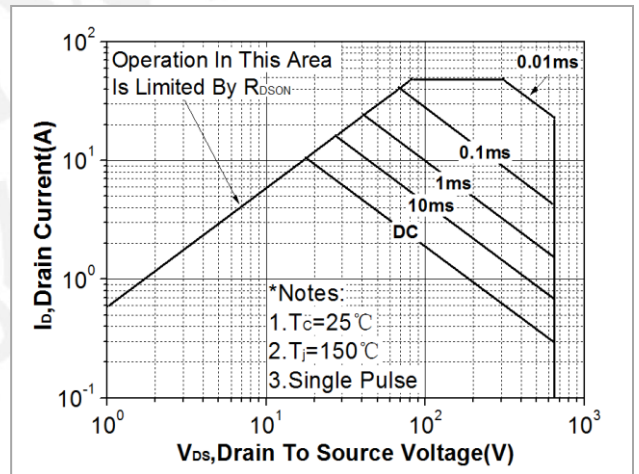

Fig. 11. Maximum safe operating area (TO-220)

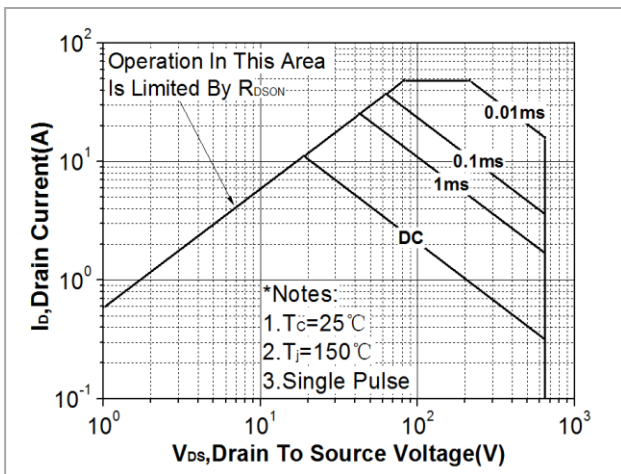

Fig. 12. Maximum safe operating area (TO-263)

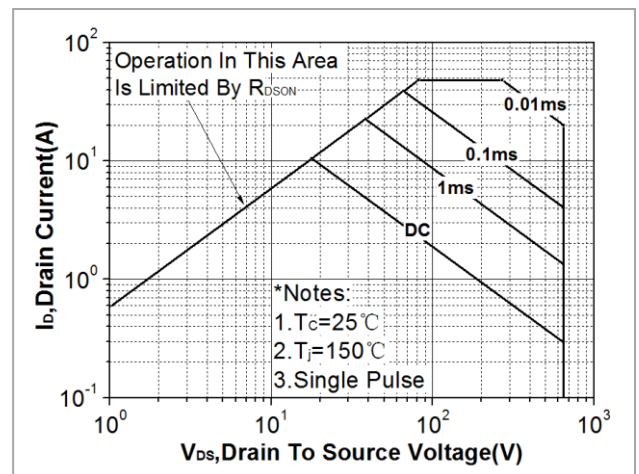

Fig. 13. Transient thermal response curve (TO-220F)

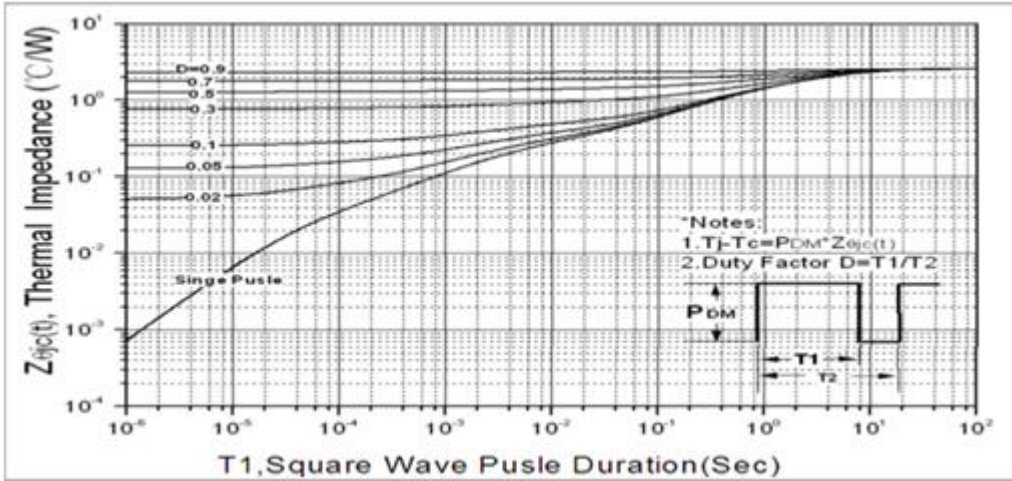

Fig. 14. Transient thermal response curve (TO-262)

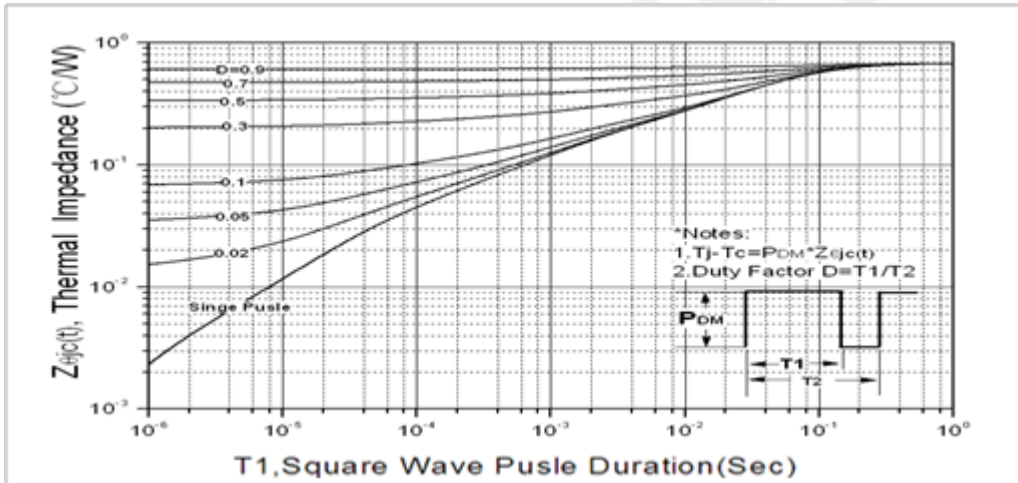

Fig. 15. Transient thermal response curve (TO-220)

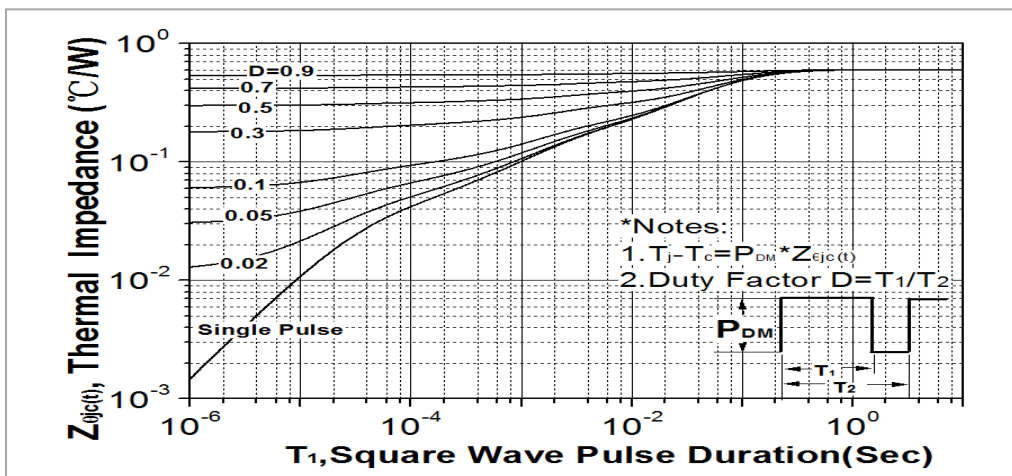

Fig. 16. Transient thermal response curve (TO-263)

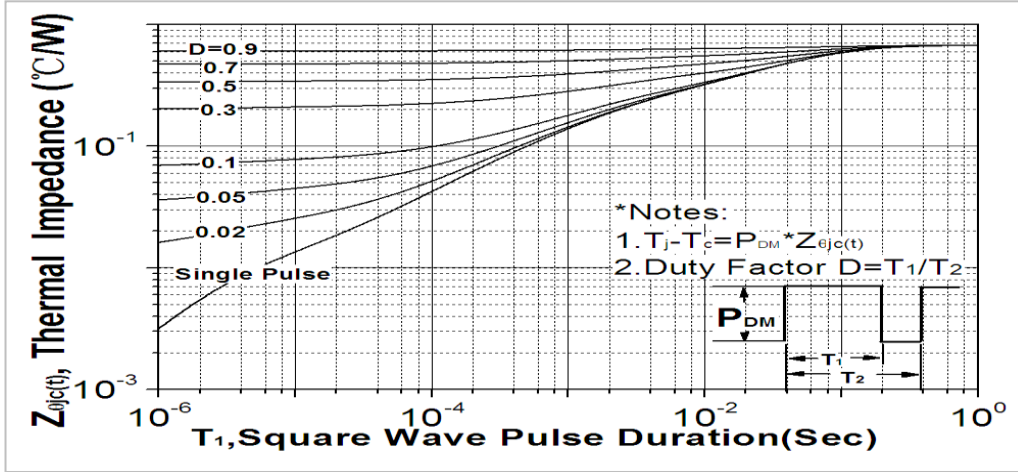

Fig. 17. Gate charge test circuit & waveform

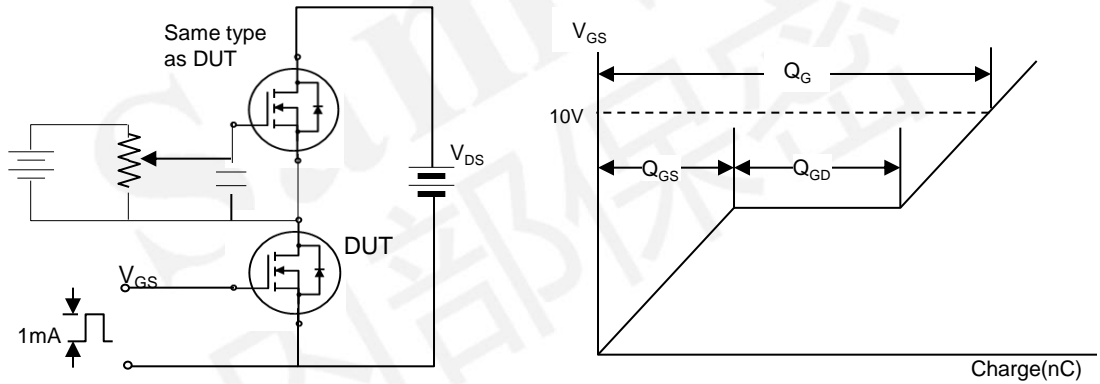

Fig. 18. Switching time test circuit & waveform

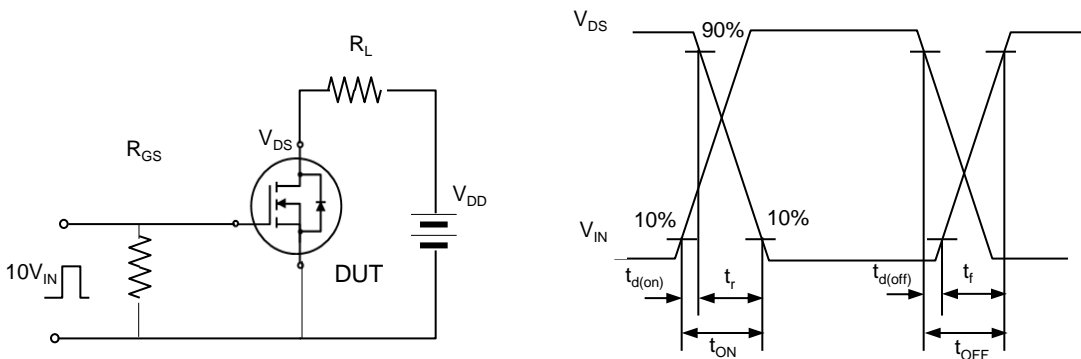

Fig. 19. Unclamped Inductive switching test circuit & waveform

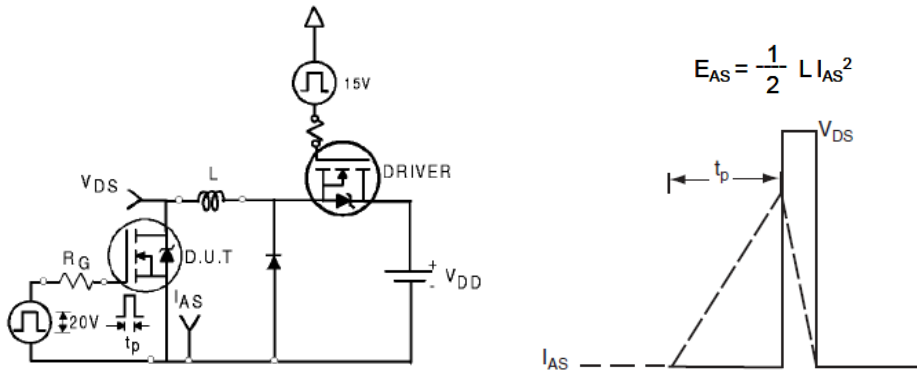
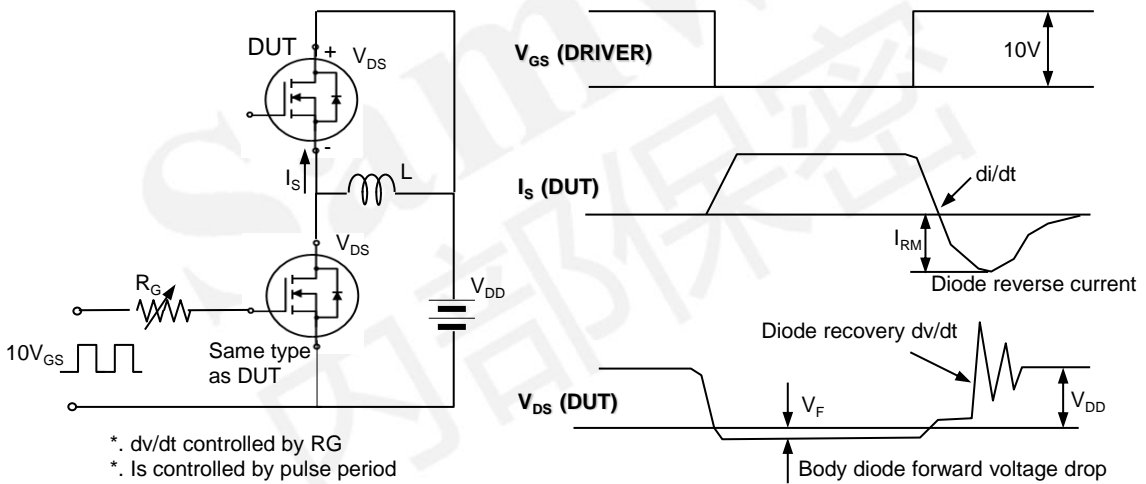

Fig. 20. Peak diode recovery dv/dt test circuit & waveform



### DISCLAIMER

- \* All the data & curve in this document was tested in SEMIPOWER TESTING & APPLICATION CENTER.
- \* This product has passed the PCT,TC,HTRB,HTGB,HAST,PC and Solderdunk reliability testing.
- \* Qualification standards can also be found on the Web site (<http://www.semipower.com.cn>)
- \* Suggestions for improvement are appreciated, Please send your suggestions to [samwin@samwinsemi.com](mailto:samwin@samwinsemi.com)